

Connections and Control

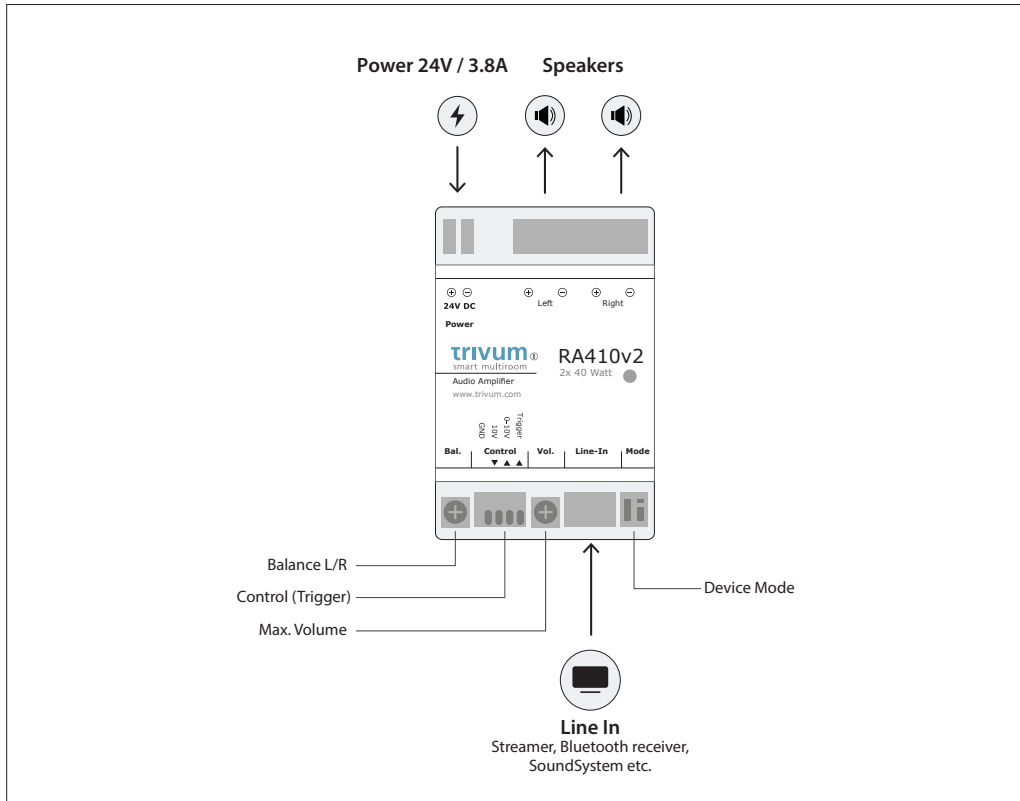

Connection example:

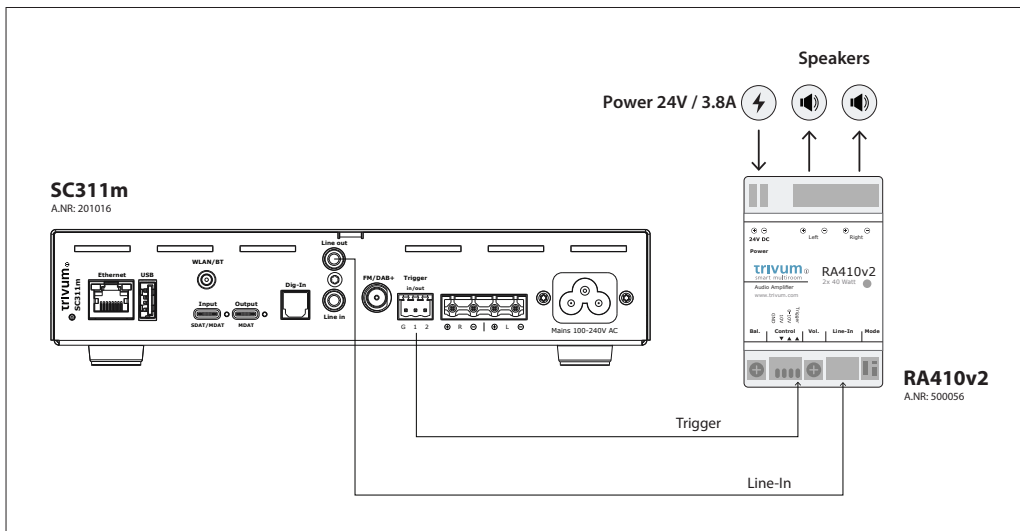

trivum
smart multiroom

RA410v2
AN: 500056

Quick Installation Guide



Required components for installation:

- 24 V DC power supply, at least 3.8A (e.g. PS24/100 3.92A by trivum AN: 500023)
- Switch wire
- Audio cable
- Speakers with 4 or 8 Ohms impedance

Technical Data

Connections	1x 0-10V input 1x Speaker Stereo (4-Pin connector) 1x Analog Line Input 3.5mm stereo jack 1x Power (2-pin connector) 1x Trigger input (5-24V)
Amplifier	Class D, 2x 40W @ 8 Ohm
Power Supply	24V DC, 3.8A 2-pin connector
Casing	REG 3 units (54 mm)
Weight	0,085 kg

1. Mounting and connection

- 1.1 Mount the RA410v2 on a 35 mm DIN-rail.
- 1.2 Connect cables to audio output (check polarity) and power supply.



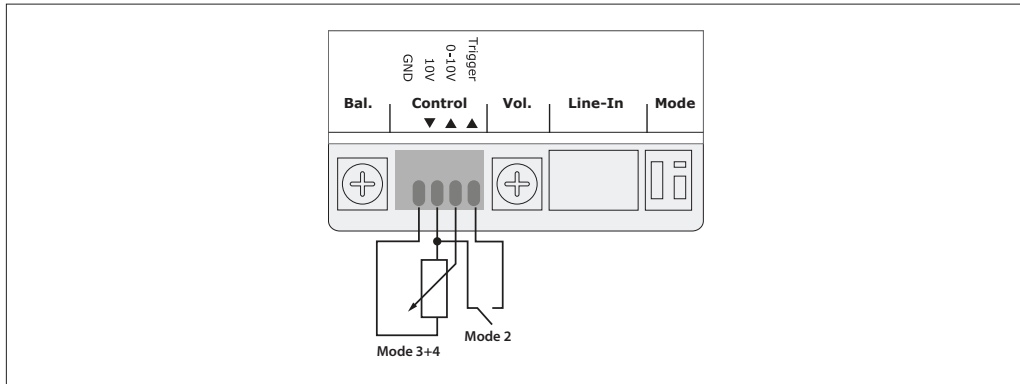

💡 **Trigger voltage:** 5-24V

⚠️ **Warning: wrong polarity may damage the device!** Double check power cable polarity before connecting!



2. Operating modes

There are four different modes to operate the RA410v2:

#	Mode	Description
1		<ul style="list-style-type: none">• Always on - device is permanently active.
2		<ul style="list-style-type: none">• trigger works as on/off• 0-10V will be ignored
3		<ul style="list-style-type: none">• 0-10V is active• the trigger is active
4		<ul style="list-style-type: none">• trigger will be ignored.• volume can be controlled with dimmer or other device.• 0-10V input is used for trigger and volume• 0-1V is off / 1-10V is on

Analog audio input

The music source is connected via a 3.5mm jack plug. By www.trivum.com we also offer adapters to connect other plugs or free cable ends to the 3.5mm jack socket.

Trigger input

So that the amplifier is not always switched on, it is possible to use the trigger input to control on/off. A DIP switch is used to set whether the trigger input should be used.

0-10V input

The volume can be adjusted with a 0-10V signal. If variable volume is not desired, the RA410v2 will operate at 100% in standard mode. The RA410v2 supplies 10V at one connection in order to use a simple potentiometer to control the volume. 0-10V signals from e.g. SmartHome control systems can also be used, or the output of a 0-10V KNX dimming actuator.

Balance and Volume control via built-in potentiometer

Two built-in small potentiometers allow you to adjust the level of the 2 amplifier channels. This enables a balance setting - and also the limitation of the maximum volume.

2 DIP switches for configuration

You can configure the amplifier with the 2 DIP switches.

Amplifier

The digital stereo amplifier delivers 2x40 watt at 8 ohms. It can drive a minimum of 4 ohm loads. This also allows you to operate a several 8 ohm loudspeakers in parallel on one output.

Thanks to the digital power amplifier, the amplifier develops little heat and is therefore suitable for DIN rail mounting. Nevertheless, it is advisable to ventilate the control cabinet sufficiently.

Further documentation and troubleshooting

Please visit also our website for the latest documentation, videos and information:

<https://www.trivum.com>
<https://service.trivum.com>

If support is needed

Please contact your local trivum dealer or write to:

service@trivum.com

trivum Apps (iOS, Android, Web)

<https://trivum.de/apps>

trivum technologies GmbH
Eierstraße 48
70199 Stuttgart
info@trivum.de
www.trivum.com

